

AMEP-VH001 holds **two 25mm x 75mm** standard microscope slides, chamber slides, etc.

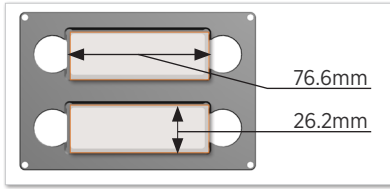

AMEP-VH002 holds **four 35mm Petri dishes**

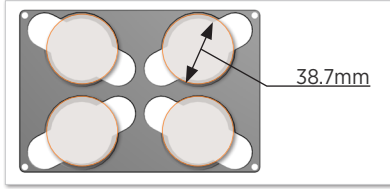

AMEP-VH003 holds **two 60mm Petri dishes**

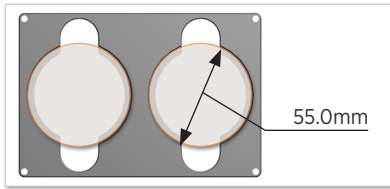

AMEP-VH004 holds **one 100mm Petri dish**

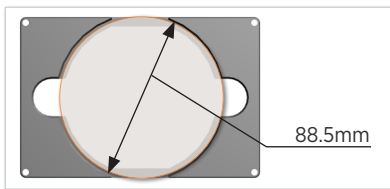

AMEP-VH005 holds **two 25cm² flasks; rectangular or triangular**

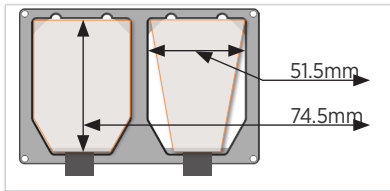

AMEP-VH006 holds **one Nunc T-75 flask; 75cm²**

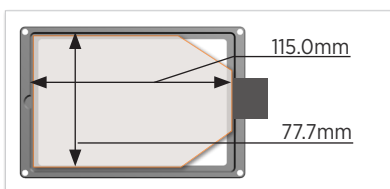

VESSEL HOLDERS & STAGE PLATES

for **EVOS[®]** Digital Inverted Microscopes

AMEP-VH007 holds **one Hemocytometer**

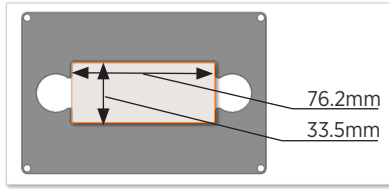

AMEP-VH012 holds **one SPL T-75 flask; 75cm²**

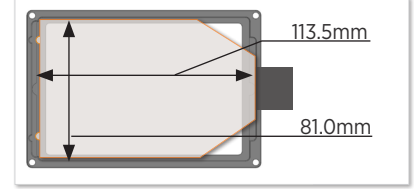

AMEP-VH008 holds **one Greiner T-75 flask; 75cm²**

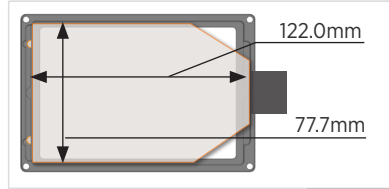

AMEP-VH013 holds **four Ibidi 35mm Petri dishes**

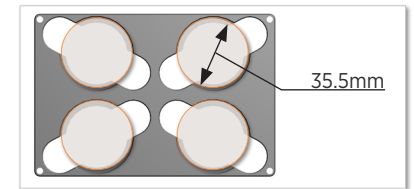

AMEP-VH009 **Universal stage insert**

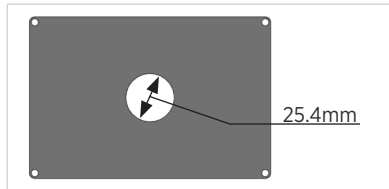

AMEP-VH014 holds **two Ibidi 50mm Petri dishes**

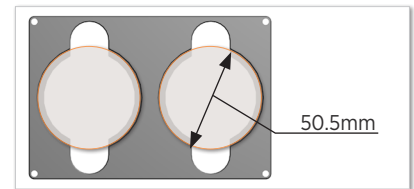

AMEP-VH010 holds **one BD/Greiner T-25 flask; 25cm²**

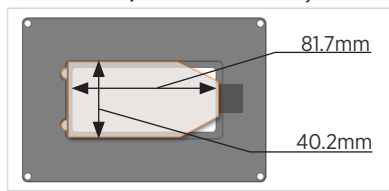

AMEP-VH017 holds **one KOVA Glasstic Slide 10**

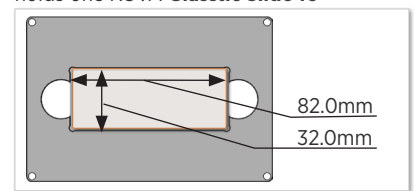

AMEP-VH011 holds **one NUNC/SPL IVF 4-well dish**

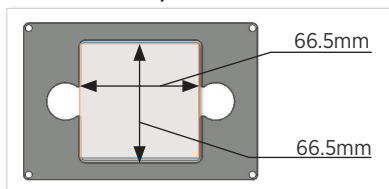

AMEP-VH018 holds **one Nunc T-25 flask; 25cm²**

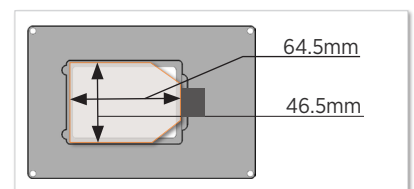

VESSEL HOLDERS & STAGE PLATES

for **EVOS[®]** Digital Inverted Microscopes

EVOS VESSEL HOLDERS & STAGE PLATES	
AMEP-VH001	Holds two 25mm x 75mm slides
AMEP-VH002	Holds four 35mm Petri dishes
AMEP-VH003	Holds two 60mm Petri dishes
AMEP-VH004	Holds one 100mm Petri dish
AMEP-VH005	Holds two 25cm² T-flasks (rectangular or triangular)
AMEP-VH006	Holds one Nunc T-75 flask
AMEP-VH007	Holds one Hemocytometer
AMEP-VH008	Holds one Greiner T-75 flask
AMEP-VH009	Holds all vessel types (plain-stage functionality)
AMEP-VH010	Holds one 25cm² BD or Griener T-25 flask
AMEP-VH011	Holds one NUNC/SPL IVF 4-well dish
AMEP-VH012	Holds one SPL T-75 flask
AMEP-VH013	Holds four Ibidi 35mm Petri dishes
AMEP-VH014	Holds two Ibidi 50mm Petri dishes
AMEP-VH017	Holds one KOVA Glasstic Slide 10 (82mm x 32mm)
AMEP-VH018	Holds one 25cm² NUNC T-25 flask
AMEP-4684	Stage Plate for heating tray, Tokai Hit Cat. No. MATS-UAXKW-D
AMEP-4685	Stage Plate for heating stage, BioFlux by Fluxion
AMEP-4686	Stage Plate for multi-well vessels ; also holds one Corning T-75 flask
AMEP-4687	Stage Plate for multi-well vessels ; allows maximum objective clearance
AMEP-4691	Stage Plate with 110mm x 160mm opening
AMEP-4692	Stage Plate Adaptor; 110mm x 160mm opening to standard opening

AMEP-4691

Stage Plate with **110m x 160m opening**
(Use with AMEP-4692 for standard sizes)

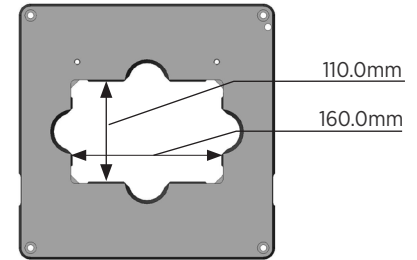

AMEP-4692 Stage Plate Adaptor;

110mm x 160mm opening to standard size
(sold separately)

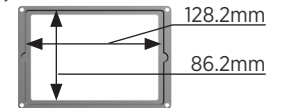

AMEP-4684

Stage Plate for **heating tray, Tokai Hit #MATS-UAXKW-D**

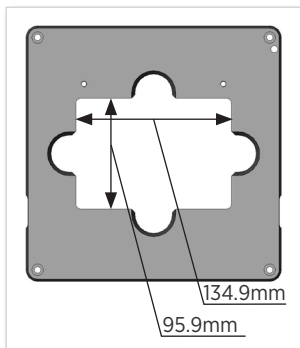

AMEP-4685

Stage Plate for **heating stage, BioFlux by Fluxion**

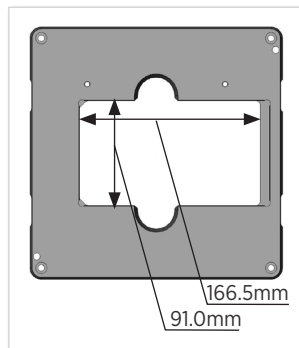

AMEP-4686

Stage Plate for **multi-well vessels**; also holds **one Corning T-75 flask**

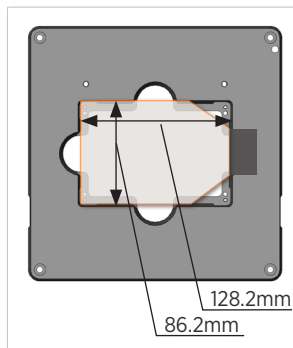

AMEP-4687

Stage Plate for **multi-well vessels**; allows maximum objective clearance

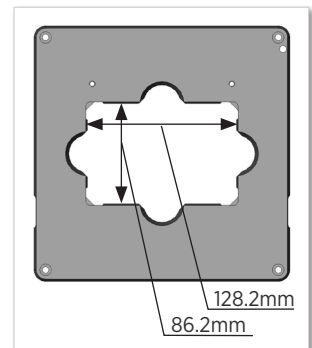

Doc Control Number ZP-PKG-0408 REV E © 2011 Advanced Microscopy Group, Inc. All rights reserved.